

SAFE USE AND CARE OF YOUR APPLIANCE

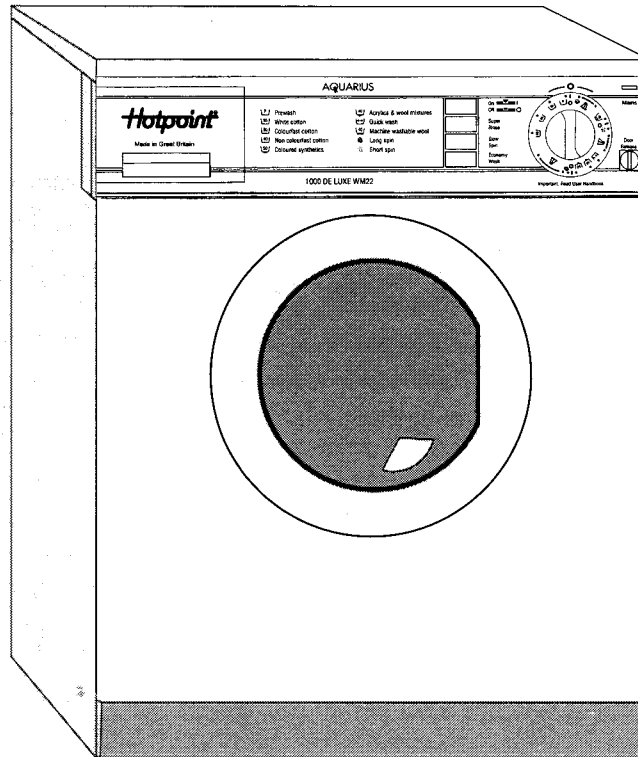

- INSTRUCTIONS FOR USE - MODELS WM12, WM13, WM20, WM21 & WM22

For your own safety and to get the best results, it is important that you read right through this handbook before using your appliance for the first time.

Hotpoint®



Contents

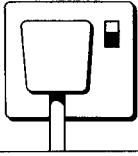

Essential Information



Getting to know your machine



Sorting your Laundry
Detergents and Fabric Conditioners



Caring for your Appliance

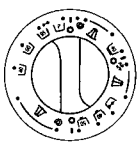

The Machine at Work

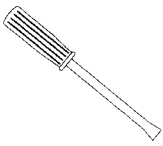

Installation Instructions



If you think that you have a problem?
If it still won't work...



Guarantee Information
Service Cover

REMEMBER THESE ESSENTIAL STEPS.....

- 1 Please read the handbook thoroughly
- 2 Identify the positions where you require your appliance
- 3 Remove the transit strap
- 4 Connect to the water supply
- 5 Connect to the drain
- 6 Connect to the Electricity supply
- 7 Finally position and Level the appliance

CONGRATULATIONS!
Your appliance is now ready for use, but please remember the safety warnings.

Essential Information

INTERNAL TRANSIT BRACKET

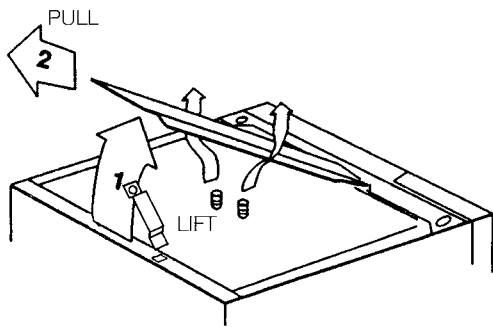

Refer to Installation Instructions



WARNING: ENSURE THAT APPLIANCE IS UNPLUGGED BEFORE REMOVING THE TRANSIT BRACKET.

Your appliance is fitted with an internal bracket which prevents damage to the machine during transit. This must be removed before the appliance is used.

Remove **ONLY** parts indicated upon the label attached to the top of your appliance.

DO NOT remove the concrete weight.

DO NOT operate the appliance with the transit bracket still in place.

BE CAREFUL – avoid any sharp edges.

RETAIN THE PARTS which you have removed, you may require them if you move house, etc.

DOOR SEAL – it may look creased, this is normal and will not affect its use.

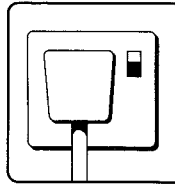

WATER SUPPLIES

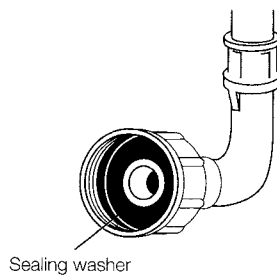
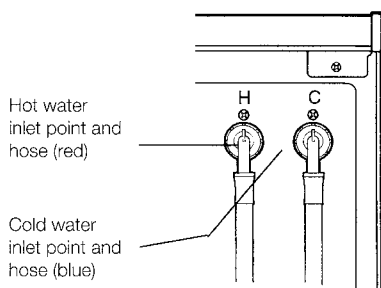

WARNING: DO NOT CONNECT THIS APPLIANCE TO A SINGLE OUTLET INSTANTANEOUS WATER HEATER.

Water pressure – should be between 3 and 150 PSI (2-103 N/cm²) for both hot and cold supplies.

Hot Water temperature – should be ideally 60°C, but **MUST NOT** be higher than 70°C. (This could cause damage to clothes and/or the machine).

Tap position – offset from your appliance and accessible when the appliance is installed.

Hose connectors – The Red hose to be connected between the **HOT** supply and the machine inlet marked 'H', and the Blue hose between the **COLD** supply and the inlet marked 'C'. Ensure that the sealing washers are in place, as shown in the diagram .

NOTE: DO NOT OVER TIGHTEN THE HOSE CONNECTORS. HAND TIGHT IS SUFFICIENT.

Tap connections – Refer to accessory list for a range of adaptors to suit your taps.

DRAINAGE

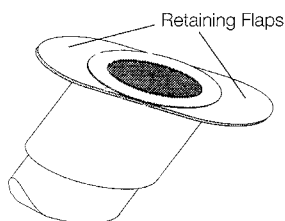

STAND PIPE DRAINAGE

UNDER-SINK DRAINAGE

SINK DRAINAGE

For Details of Drainage Installation see 'Installation Instructions' in this book.

IMPORTANT NOTICE: FOR THE CORRECT OPERATION OF YOUR APPLIANCE IT IS ESSENTIAL TO COMPLY WITH THE FOLLOWING INFORMATION.

DO NOT remove the hooked end support of the drain hose, and ensure that the pipe is not pushed too far down the standpipe. If the end of your drain hose is fitted with 'retaining flaps', ensure that they are fully inserted into the standpipe. **DO NOT** position the standpipe near an electrical outlet.

Remove any restrictions from the waste spigot, and ensure that the hose is routed such that it is raised to a minimum height of 31½" (800mm).

Ensure that the end of your drain hose is above the water level in the sink to avoid syphoning.

Essential Information

SUPPLY

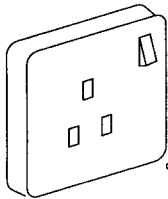
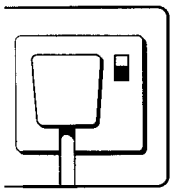

220/240v

50Hz

Earth



This appliance should be connected to the mains supply via a suitable switched socket in an accessible position.

WARNING: THIS APPLIANCE MUST BE EARTHED.

FUSES

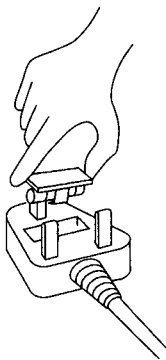

Your appliance comes fitted with a plug and a 13A fuse. If you need to replace the fuse, only those rated at 13A and ASTA approved to BS1362 should be used.

The fuse cover **MUST** be re-fitted after changing the fuse.

WARNING: DO NOT USE THE PLUG UNLESS THE FUSE COVER IS FITTED.

If you lose the fuse cover, a replacement may be obtained from an authorised Service Centre (see list supplied), or an Electricity company.

The correct replacement is identified by the colour coding, or marking on the base of the plug.

CHANGING THE PLUG



If the plug does not fit your socket, you can cut it off and dispose of it.

WARNING: DO NOT INSERT THIS PLUG INTO A SOCKET ELSEWHERE AS THIS COULD CAUSE A SHOCK HAZARD.

IMPORTANT: THE WIRES IN THE MAINS LEAD ARE COLOURED IN ACCORDANCE WITH THE FOLLOWING CODE:

Green/Yellow	–	Earth
Blue	–	Neutral
Brown	–	Live

If you change the plug, the colours of the wires in the mains lead may not correspond with the colours of the markings identifying the terminals in the plug. You should therefore wire it as shown (see illustration).

If the mains lead needs to be replaced at any time, it should be replaced by a special lead obtainable from your local authorised Service Centre. A charge will be made if you have damaged the existing lead or require a longer one. It is strongly advised that this work is carried out by a qualified electrician.

Green and yellow (Earth) wire to the terminal marked 'E' or with the symbol , or coloured green and yellow.

Blue (Neutral) wire to the terminal marked 'N' or coloured black.

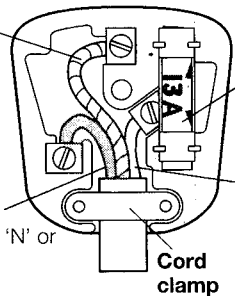

13A ASTA approved fuse to BS1362.

Brown (Live) wire to the terminal marked 'L' or coloured red.

Cord clamp

NOTE: CE marking certifies that this appliance complies with the requirements laid down in EEC Directive 89:336 (Electromagnetic compatibility) and subsequent modifications and Low Voltage direction 73/23/EEC.

Essential Information

SAFETY

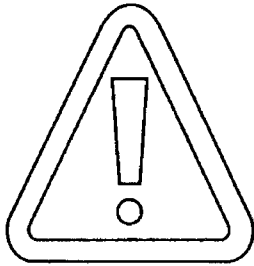

WARNING: DO NOT ALLOW CHILDREN TO PLAY WITH THE APPLIANCE OR TAMPER WITH, THE CONTROLS.

WARNING: IT IS POSSIBLE FOR CHILDREN AND ANIMALS TO CLIMB INTO WASHING MACHINES AND INJURE THEMSELVES.

WARNING: DO NOT TOUCH THE DOOR GLASS WHEN THE MACHINE IS OPERATING, AS THIS CAN BECOME HOT.

WARNING; WHEN SWITCHING THE APPLIANCE ON OR OFF, ENSURE THAT YOUR HANDS ARE DRY.

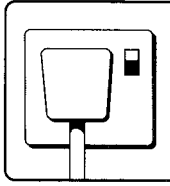

POSITION

You should choose the position of your appliance carefully, as it will influence how well it performs, ie...

POSITION THE APPLIANCE, WHERE POSSIBLE, ON A SOLID FLOOR. You may get some vibration with a wooden floor.

TAKE CARE WITH VINYL FLOOR-COVERINGS. *The weight of the appliance may cause indentations in some vinyl floor coverings.*

TO COMPLY WITH REGULATIONS, YOU SHOULD NOT INSTALL YOUR APPLIANCE IN A BATHROOM OR SHOWER ROOM. *Seek professional advice if you wish to do so.*

ENSURE THAT YOU HAVE LEFT SUFFICIENT SPACE FOR THE APPLIANCE.

The aperture dimensions should be a minimum of....

600mm Wide ($23\frac{5}{8}$ "). 600mm Deep ($23\frac{5}{8}$ ").

and 900mm High ($35\frac{1}{2}$ "

ENSURE THAT THE SWITCHED SOCKET IS EASILY ACCESSIBLE.

ENSURE THAT THE WATER TAPS ARE IN AN ACCESSIBLE POSITION, AND THE WATER SUPPLY CAN BE ISOLATED IF NECESSARY.

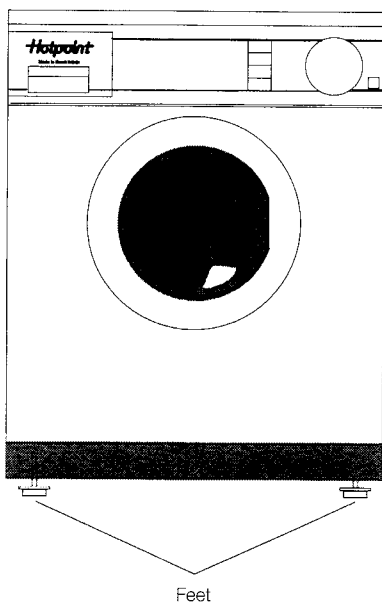

LEVELLING

IT IS ESSENTIAL THAT THE FEET ARE ADJUSTED TO ENSURE THAT THE APPLIANCE IS LEVEL AND ALSO TO PREVENT IT ROCKING.

If the appliance is not firm and level, it may become noisy or move about the floor during spin. To comply with regulations, your machine should be level within 2°.

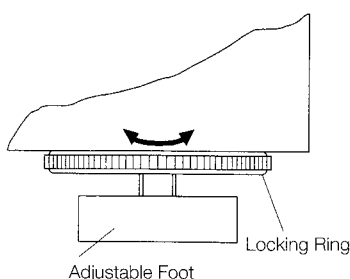

Getting to know your Machine

KNOW YOUR MACHINE

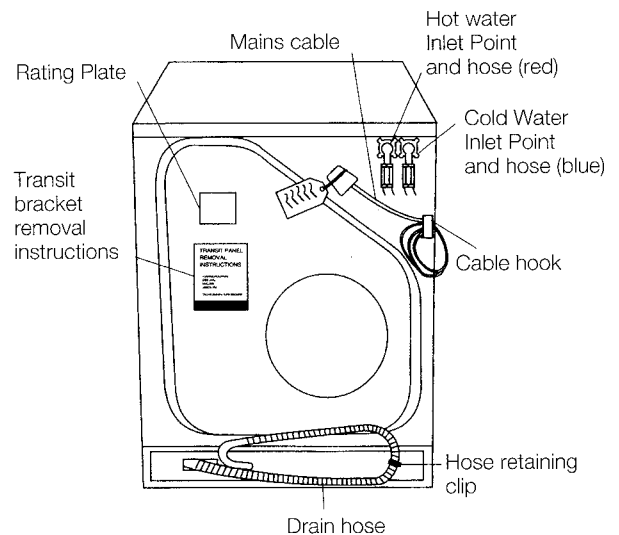
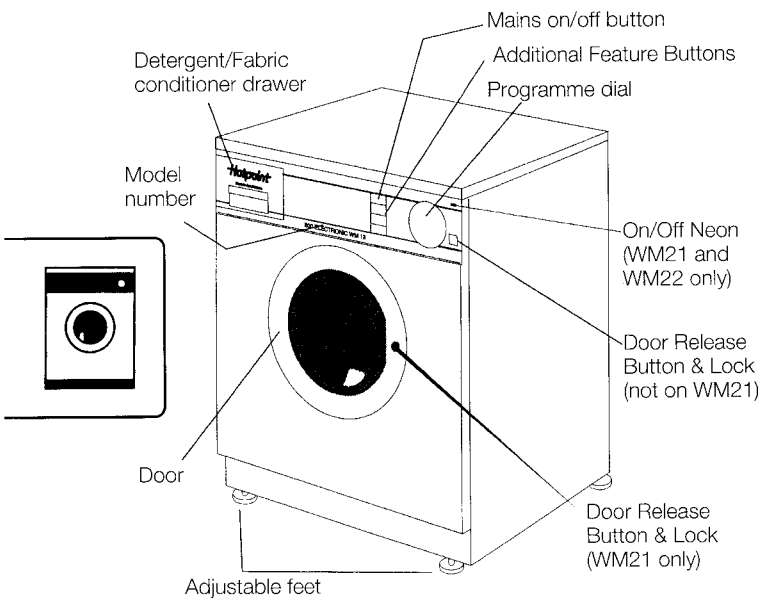

PREPARATION FOR USE

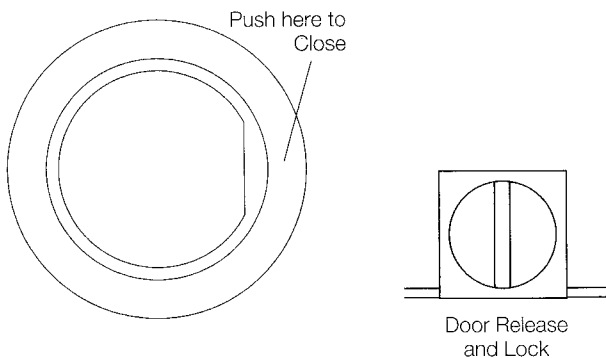

A typical Wash cycle eg: garments with a λ_{40} symbol.

Turn on the hot and cold water supplies.

Plug in and switch on the electricity. **IMPORTANT: ENSURE THAT YOUR HANDS ARE DRY.**

Sort out the clothes for a λ_{40} wash.

Open the door by pressing in the Door Release Button.

Load your clothes into the machine (*with detergent dosing device, if required*).

Push the door firmly to close.

If children are nearby, it is recommended that you lock the door by turning the slot to a horizontal position.

STARTING THE WASH

Select the programme required by turning the knob **CLOCKWISE** until the correct symbol is in the 12 o'clock position. Each wash position has a positive select point, which can easily be detected when turning the knob slowly.

Add the detergent and fabric conditioner into the appropriate compartments in the dispenser drawer.

Press On/Off button – (The mains neon will light up on WM21 and WM22). You will hear the sound of the water flowing into the machine.

DURING THE CYCLE

Your machine will wash, rinse and spin.

Your machine has a feature to prevent it spinning with a large unbalance in the wash load

For further information see 'The Machine at Work'.

WHEN THE CYCLE HAS FINISHED

Release the On/Off button.

If safety lock has been engaged, prior to start of wash, turn the slot to a vertical position.

Open the door, by pressing the door release, and remove the clothes (*and the dosing ball if used*).

Switch off the electricity and water after every wash session.

Getting to know your Machine

PROGRAMMING

Label codes		Temp
New	Old	°C
		95
		60
		50
		40
		40
		40

To select a programme turn the selector knob clockwise until the required programme symbol is at the 12 o'clock position.

The symbols on the dial correspond to the international wash care symbols, which you will find on your clothing. These indicate the recommended wash required for that fabric eg:

Fabric	Max Load
	kg (lb)
White cotton and linen without special finishes.	5 (11)
Colourfast cotton, linen or viscose without special finishes.	5 (11)
Coloured Nylon Polyester Acrylic/cotton mixtures cotton or viscose without special finishes (eg drip-dry), coloured Polyester/cotton mixtures.	3 (6.5)
Non-colourfast cotton, linen and viscose.	5 (11)
Acrylics, acetates & tri-acetates blends of these fabrics with wool, and polyester/wool blends.	3 (6.5)
Woollen blankets, wool mixtures with cotton or rayon, silk. Shrink-resistant machine washable and superwash woolmark garments.	2.7 (6) 1.4 (3)

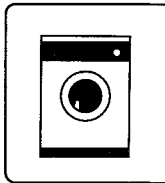

ADDITIONAL PROGRAMMES

PREWASH

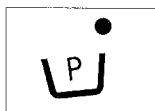

The following may be selected if required....

Select prewash for really dirty clothes. Prewash heats water to a temperature of 40°C.

When the prewash is complete the programme selector will stop at the symbol . You should then switch the appliance off, turn the knob to the required main wash and switch on. DO NOT Use for woollens or machine washable wool.

QUICK WASH



A quick cool wash, without heating the water, to freshen up lightly soiled items in about 30-35 minutes. Maximum load 0.9kg (2lb).

DO NOT Use for woollens or machine washable wool.

SPIN



LONG SPIN

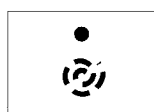

SHORT SPIN

Long spin for robust fabrics.....Short spin for delicate fabrics. DO NOT fill more than half full with wet clothes. At the end of the spin cycle, there will be a few short tumbles before the programme finally finishes.

OTHER SYMBOLS

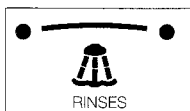

RINSES

For a rinse or a rinse and spin programme. Depending on the type of fabric, select the correct rinses programme **before** the spin that you require.

First dot will give most rinses and last dot least rinses.

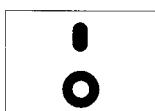

END OF PROGRAMME

Getting to know your Machine

ADDITIONAL WASH OPTIONS

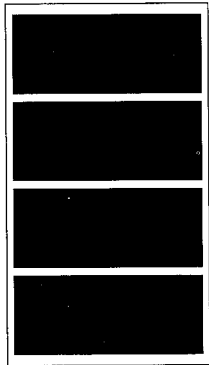
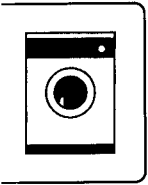

On
Off

Super
Rinse

Slow
Spin

Economy
Wash



For Models WM13 and WM22

WARNING: DO NOT FORGET TO CANCEL BUTTONS AT THE END OF A PROGRAMME.

One or more of the option buttons may be selected to give you the versatility of the wash programme which you select. Select your wash option(s). Press the button(s) again to cancel the option.

MAINS ON/OFF BUTTON

Press in the On/Off button to start the wash programme. On completion of the programme release the On/Off button.

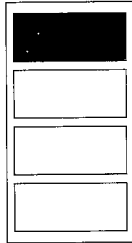

SUPER RINSE

By pressing this button the water level for each rinse, on all programmes, will increase.

Use with heavy soiled clothes or if people have sensitive skin.

Do not use on the woollen programme $\frac{40}{}$ as this programme automatically has increased water level on rinses.

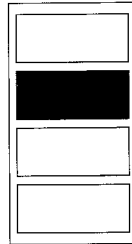

SLOW SPIN

The machine normally spins at 800rpm (WM12 & 13) or 1000rpm (WM20, 21 & 22). Pressing this button reduces the spin speed to 500rpm, which will reduce creasing in delicate fabrics.

Slow Spin does not get clothes quite as dry as a normal spin.

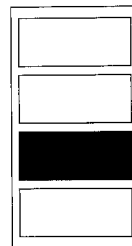

ECONOMY WASH

For lightly soiled washing. This will save electricity and time. Economy Wash switches off the heater in the machine so that your clothes are washed at the temperature of the water entering the machine from your hot and cold water supplies. This saves you electricity but means a cooler wash. Use Economy Wash for lightly soiled clothes, not for really dirty clothes.

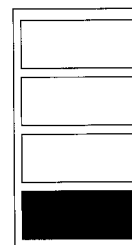

Getting to know your Machine

ADDITIONAL WASH OPTIONS

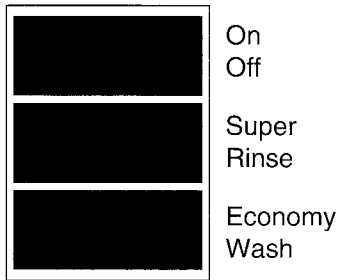

For Model WM12

For a description of the buttons shown, see opposite page.

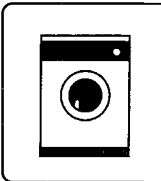

ADDITIONAL WASH OPTIONS

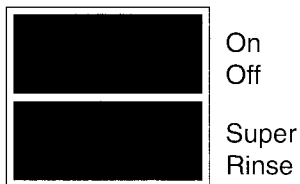

For Model WM20

For a description of the buttons shown, see opposite page.

ADDITIONAL WASH OPTIONS

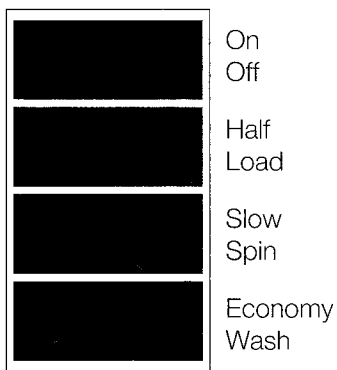

For Model WM21

For a description of the buttons shown, see opposite page, except for Half Load button which is described below.

HALF LOAD

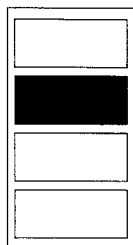

For small wash loads only. Reduces the amount of water the machine uses, saves detergent, time and the electricity to heat the water.

Do not use on the woollen programme 40 as this programme automatically has a high water level.

Sorting your Laundry

PREPARING THE LOAD

Each item of clothing has a label which indicates the programme that the item should be washed on.

Sort our clothes into common label types eg $\sqrt{50}$ (new style) or $\sqrt{\frac{4}{50}}$ (old style).

Separate clothes into light and dark colours.

You will notice that the wash label symbols are printed on the programme knob – Each indicates a programme.

OTHER WASH CARE SYMBOLS

Other symbols may appear on the garment labels, but do not appear on the washing machine.



Wash by hand.



Hand wash only.



Do not machine wash.



Use bleach, preferably chlorine household bleach eg. Domestos.

DO NOT use bleach in your machine.



DO NOT bleach at all.

Some labels may include DRY CLEANING codes such as shown.



Clothes with these letters on the label indicate that you should not wash them in your machine (unless the label states otherwise)



DO NOT DRY CLEAN.

DO'S AND DONT'S FOR SUCCESSFUL WASHING



DO pretreat stains immediately before washing, if you have not done so when it happened.

DO scrape off excess cream/lotion from nappies etc before washing. Use a prewash for these items to prevent the cream from being transferred to other clothes.

DO close all zips, tie belts, strings and press studs to prevent tangling.

DO remove all items from pockets before washing.

DO wash blankets and bedspreads on their own – not as part of a load – this will ensure adequate washing and rinsing.

DO limit the size of load of absorbent items (towels, nappies) to 3kg (7lb) to give good washing/rinsing results.

DO place small items in a wash bag.

DO check the wash label on items such as cotton T-shirts, they may require a cool programme.

DO wash as full a load as possible to obtain the maximum cost and time efficiency.



DO NOT wash non-colourfast items, woollens or really dirty clothes in a mixed wash – they may affect other items.

DO NOT leave sharp objects on clothes or coins in the pockets they could cause damage to other clothes.

DO NOT overload your machine – clothes will not wash properly.

DO NOT machine wash clothes which do not have a wash label.

Detergents and Fabric conditioners

DETERGENT TYPES

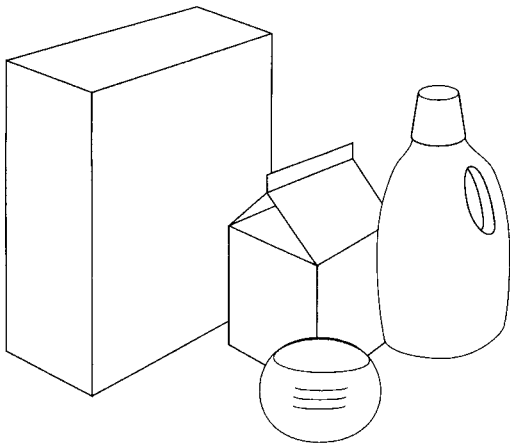

There are now many different makes and types of detergent available eg: Powders, Concentrated powders, Liquids and Concentrated liquids etc.

Whatever detergent that you choose, you should follow some basic rules to obtain the best wash results. Always use "low suds" automatic powders, which are designed for automatic washing machines.

Follow the manufacturer's recommendations regarding the correct dose that you should use.

REMEMBER – You will need more detergent in hard water areas (up to 50% more) than in soft water to obtain the same wash results.

DO NOT underdose – your clothes will not be washed clean.

DO use the liquid detergent dispenser (**Part No. 9003**) for dispensing any liquid EXCEPT those used with a dispensing ball.

DO NOT try and use the drawer to dispense powders or liquids intended for use with a ball.

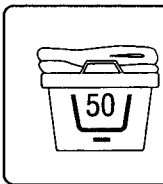

DETERGENT & FABRIC CONDITIONER – WHERE TO PUT IT

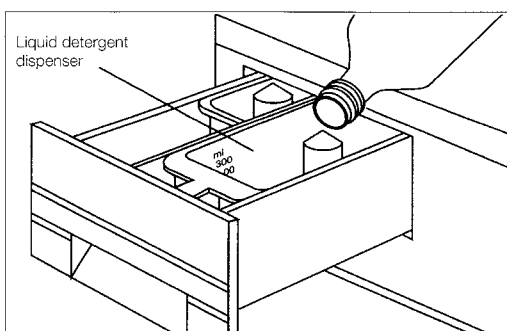
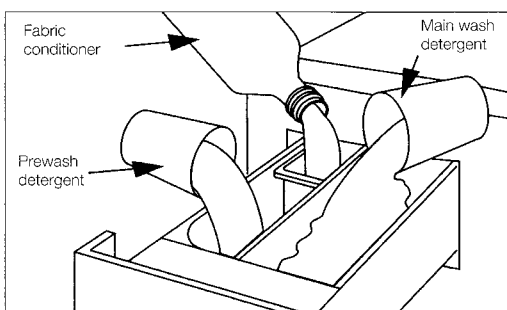

THE FOLLOWING INFORMATION APPLIES ONLY TO DETERGENTS AND FABRIC CONDITIONERS INTENDED FOR USE IN THE DISPENSER DRAWER.

You place the detergent and conditioner in the appropriate compartments in the pull out drawer on the left of the machine (See diagrams).

Using the liquid detergent dispenser, Which is available as an accessory. (**Part No. 9003**)

Caring for your appliance

AFTER EACH WASH

When the programme has finished, you should always remember the following....

Release the On/Off button.

Cancel any feature buttons that you may have selected.

Open the door, (unlock door if applicable) remove the clothes and then rotate the drum in order to check for small items (socks etc) left behind.

REGULAR CLEANING

It is advisable to clean the Appliance at regular intervals.

DISPENSER

To clean the dispenser and dispenser drawer you should pull out the drawer until it reaches its stop. Remove the fabric conditioner compartment, lift drawer lightly and give a sharp tug to remove it completely.

Clean fabric conditioner compartment and push the cap firmly back into place in the compartment.

Clean and dry the dispenser drawer thoroughly.

Replace the conditioner compartment in the dispenser drawer, with the cap towards the back.

To re-locate the drawer into the machine, hold the drawer with the flap towards the appliance, and locate it under the top of the dispenser opening. With the drawer partially open check that the flap at the back of the drawer is in place correctly and moves freely.

Push the drawer firmly back into place.

Clean exterior surfaces with a damp cloth or Silicon polish only.

IMPORTANT: DO NOT use abrasive cleaners, scouring agents, acids, chlorine based bleach, or metal polish to clean any part of your machine – it *may cause damage*.

EXTERIOR SURFACES

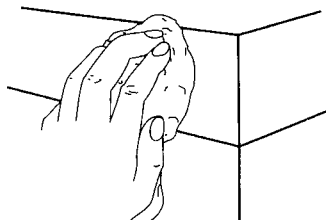

ANNUAL CHECK

We recommend that you take out a service cover plan with an Annual safety/maintenance check, which ensures that your appliance is professionally serviced.

As some components such as rubber seals and hoses can wear or perish over a period of time, a regular check for electrical and mechanical safety will avoid potential leaks which otherwise may become dangerous if left unattended.

The Machine at Work

WASHING MACHINES

Most Washing Machines work in the following way...

1. The appliance will first fill with water, while occasionally tumbling the load to mix in the detergent.
2. HEAT the water to the required temperature. *This may take some time, so do not worry if nothing appears to be happening.*
3. WASH the clothes by tumbling, stopping and reverse tumbling in the soapy water.
4. RINSE the detergent from the clothes with fresh cool water.
5. DISPENSE FABRIC CONDITIONER (where added) on the final rinse.
6. SPIN the load to remove the excess water.

THIS MACHINE

The machine is prevented from spinning if the wash load is unevenly distributed around the wash drum. Do not call for a Service Engineer. Re-distribute the washed clothes by hand and re-select the appropriate spin only programme. We do not recommend that large, bulky items are washed on their own, as it is not always possible to evenly distribute these around the wash drum. At the end of the spin cycle there will be a few short tumbles before finally finishing.

HOW LONG SHOULD WASH TAKE?

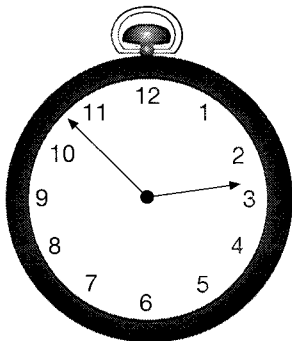

The duration of a wash programme will depend on many factors, for example...

1. The water pressure – *this influences the rate at which the water flows into the appliance, and hence how long it will take to achieve the required water level.*
2. The temperature of the incoming water – *it will take far longer to reach the desired temperature if the water is cooler.*
NOTE: IF THE INCOMING WATER IS HIGHER THAN THE RECOMMENDED WASH TEMPERATURE, YOU MAY DAMAGE THE WASH LOAD.
3. The features selected – *Certain features have a great effect on the wash duration eg: Economy Wash (washes at incoming hot water temperature, so no heating).*
4. The type and weight of clothes load – *Some fabric types are more absorbent than others, and will therefore require more water for the wash.*
5. The programme selected – *The temperature, wash cycle and rinse/spin combination associated with any particular programme selected will influence the duration.*

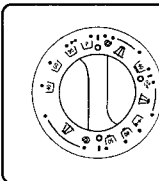

EXAMPLE PROGRAMME TIMES

PROGRAMME	APPROX TIME/mins
$\sqrt{95}$ / $\frac{1}{95}$	115-120
$\sqrt{60}$ / $\frac{2}{60}$	75-80
$\sqrt{50}$ / $\frac{4}{30}$	50-55
$\sqrt{40}$ / $\frac{5}{40}$	60-65
$\sqrt{40}$ / $\frac{6}{40}$	40-45
$\sqrt{40}$ / $\frac{7}{40}$	35-40
$\sqrt{\bullet\bullet}$	30-35
\sqrt{P} PREWASH	20-25
ECONOMY WASH	save up to 15 mins.

Installation Instructions

TRANSIT BRACKET REMOVAL

THIS BRACKET IS USED TO PROTECT YOUR MACHINE.
DO NOT DISTURB ANY OTHER FITTINGS.
DO NOT REMOVE THE CONCRETE BALANCE WEIGHT.

WARNING: THE APPLIANCE MUST BE UNPLUGGED BEFORE REMOVING BRACKET.

1. REMOVE SCREWS FROM THE WORKTOP LID.

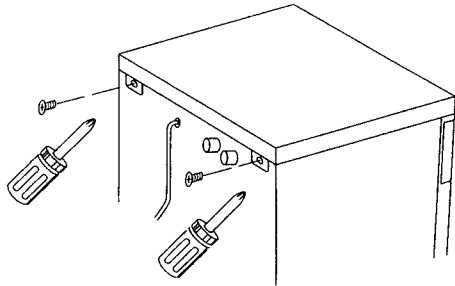

2. REMOVE WORKTOP LID – PUSH FROM THE FRONT AND LIFT UP.

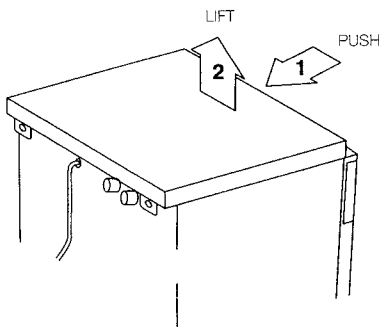

3. REMOVE THE 3 SCREWS HOLDING TRANSIT BRACKETS.

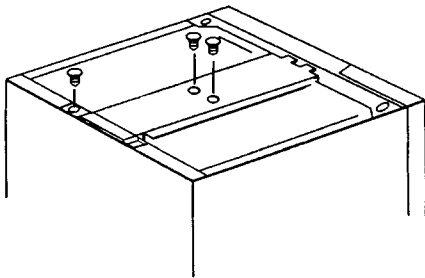

4. REMOVE BRACKETS AND 2 WHITE PLASTIC SPACERS.

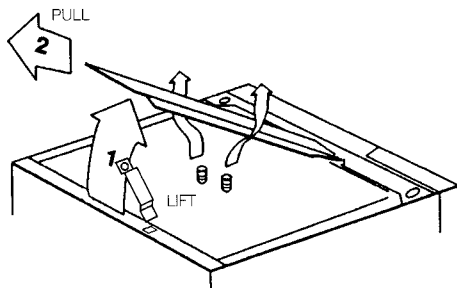

5. REPLACE WORKTOP LID AND SCREWS.

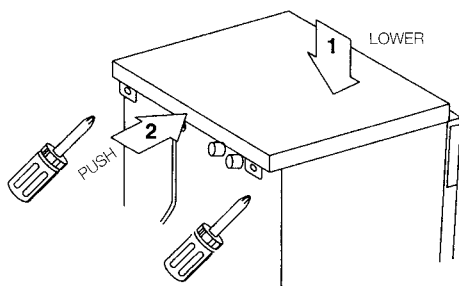

KEEP TRANSIT BRACKETS AND WHITE SPACERS FOR FUTURE USE.

Installation Instructions

DRAINAGE



WARNING: ONLY CONNECT YOUR MACHINE DRAIN HOSE TO PIPES WHICH CONNECT TO THE FOUL DRAIN SYSTEM, AND NOT TO SURFACE WATER DRAINS.



IMPORTANT NOTES: FOR THE CORRECT OPERATION OF YOUR APPLIANCE IT IS ESSENTIAL TO COMPLY WITH THE FOLLOWING INFORMATION.

INTO A STANDPIPE

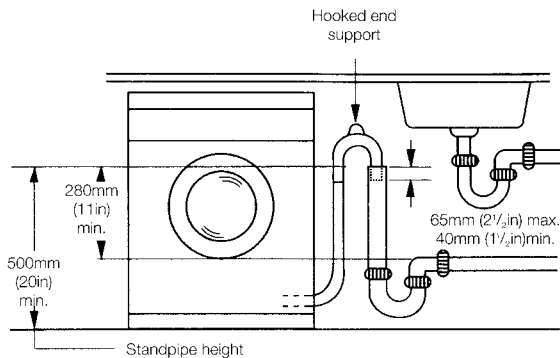

DO NOT remove the hooked end support from drain hose and ensure that the hose is not pushed too far down the standpipe. If the end of your drain hose is fitted with 'retaining flaps', ensure that they are fully inserted into the standpipe. This will prevent the pipe from jumping out during installation and machine use.

DO NOT position the standpipe near an electrical outlet.

ENSURE that the drain hose is routed as shown in the diagrams – depending on the method of connection which you choose.

The standpipe should be connected to -

- a) A discharge stack-pipe or
- b) An external gully or
- c) A sink waste.

The standpipe should have a bore of at least 38mm (1 1/2"). It should be installed as shown, have a trap fitted and must discharge into the same drain system as your household sink. It must NOT be connected to a surface water drain.

INTO A SINK WASTE SYSTEM

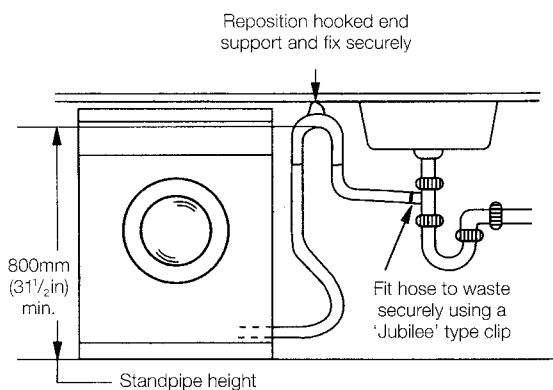

FOR UNDER SINK DRAINAGE: BEFORE CONNECTING THE DRAIN HOSE, REMOVE ANY INTERNAL RESTRICTIONS – THIS WILL PREVENT A BUILD UP OF DEBRIS WHICH COULD CAUSE A BLOCKAGE.

Remove any restrictions from the waste spigot, and ensure that the hose is routed such that it is raised to a minimum height of 800mm (31 1/2").

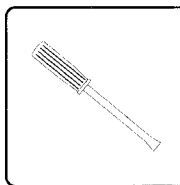

INTO A SINK

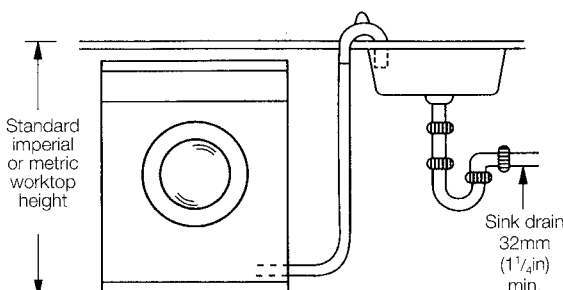

Your machine will drain into a standard worktop sink, providing the sink has an outlet pipe of at least 32mm (1 1/4") inside diameter.

Make sure that the sink plug, dishcloths, etc. do not fall into the sink and block the outlet whilst the machine is working. Ensure that the end of the drain hose is above the water level in the sink to avoid syphoning.

If your sink is inset, the front edge of the basin must be less than 75mm (3") from the front edge of your worktop.

If you think that you have a Problem

Look at this list, then check the adjacent suggestions. They may give the answer to your problem without having to telephone your Hotpoint Service office.

If you are unable to solve your problem, follow the advice under the heading 'If it still won't work'.

Machine not spinning at end of programme

Before calling Hotpoint Service please check the following:-

The machine is prevented from spinning if the wash load is unevenly distributed around the wash drum. Do not call for a Service Engineer. Re-distribute the washed clothes by hand and re-select the appropriate spin only programme. We do not recommend that large, bulky items are washed on their own, as it is not always possible to evenly distribute these around the wash drum.

If your appliance will not start, fill or take in detergent...

- *Is the machine plugged in and switched on?*
- *Is the socket OK? Try another appliance in the socket Is the fuse in the machine plug OK? If not, replace it.*
- *Are the hoses correctly connected, the taps turned fully on and the hoses not kinked?*
- *Have you selected the correct programme?*
- *Have you pressed the on/off button?*
- *Have you closed the door firmly?*

It will not pump out the water...

Has the drain hose been installed correctly? Is the hose kinked? If you have connected to a sink waste pipe, is the spigot blocked?

The door will not open...

Your appliance is designed so that the door cannot be opened there is water in the drum, or if the drum is rotating.

- *Did you lock the door?*
- *Has the programme finished?*
- *If it has finished the programme, then select a spin programme and wait for this to finish before you try again.*
- *If it still will not open, then check that the drain hose is correctly installed and not kinked.*
- *If none of these work, and you think there is still water in the appliance, refer to the "emergency" instructions on the next page.*
- *Are the fill hoses tightened correctly? Perhaps the washers are not sealing properly?*
- *Is the standpipe blocked? Or is your household drain blocked? If you cannot clear the blockage you will need to call a plumber.*
- *After the initial fill, the appliance may sometimes pause while the water is heated to the correct temperature. The cycle will continue as normal when the selected temperature is reached.*

It's leaking...



It has stopped in the middle of a programme...

The clothes are not dry enough...

- *Did you use a short spin programme on a non-synthetic load?*
- *Did the water pump out? Check your waste plumbing setup.*
- *Was slow spin selected (if fitted)?*
- *Was the wash load out of balance?*

If you think that you have a Problem

The programme seems to take a long time...

Some programmes do take a long time. See the 'Example Programme Times' in the "The Machine at Work" section. Other things which can extend programme times include:

- Low water pressure*
- Low temperature of the incoming hot water*

It makes a noise or vibrates during spin...

Your appliance will make some noise, especially during spin cycles. Small loads of heavy or bulky items (towels etc) can occasionally cause out of balance conditions, but the machine will usually sort itself out. If the noise is excessive you should check the following:

- *Has the transit bracket been removed? (see 'Installation Instructions' in this book).*
- *Have you removed loose items (coins etc) from the pockets (these can rattle about inside the appliance drum).*
- *Have you adjusted the feet to make the appliance level and steady? See 'levelling' in the section "Essential Information".*

The powder dispenser drawer will not close properly...

- *Is the drawer clogged with detergent? (clean the dispenser)*
- *Has the flap at the back of the drawer been fitted correctly? (see 'Cleaning' in the section "Caring for your Appliance")*

Steam is coming from the dispenser...

During hot washes the machine is designed to vent the steam from the dispenser drawer.

Suds are coming from the dispenser...

- *Have you used the correct amount of detergent suitable for automatic washing machines? (If you use the wrong type you will need to flush this from your appliance by selecting rinse programmes).*

EMERGENCY DOOR OPENING...

If your machine is full of water, with your clothes inside, you can open the door by following these instructions. You will need a bucket. First you will have to empty some of the water so that the safety latch will release the door.

WARNING: BE VERY CAREFUL, THE WATER IN THE DRUM MAY BE VERY HOT. If you believe that the water is very hot, allow time for cooling down (at least an hour).

If you have difficulty with access to the drain hose, it is advisable NOT to carry out this procedure.

1. Turn off the hot and cold taps, switch off the electricity at the socket and remove the plug. Do not use the machine until the Service Engineer has called.
2. Pull out your machine so that you are able to get to the back of it.
3. Place the end of the drain hose into the bucket to drain off the water. Drain off about two buckets of water.
4. When sufficient water has been removed, you should be able to open the door.



If it still won't work...



0541 500500
in the UK

**(For Eire, Channel Isles,
Isle of Man, Shetland,
Orkney and Western Isles
– see back cover)**

If something is still wrong with your appliance after you have been through the check lists:

1. Switch off and unplug your machine from the electricity supply.
2. Turn off the hot and cold water taps.
3. Call Hotpoint Service of your local importer (outside the UK).

When you contact us, we will want to know the following:

1. Your name, address and post code.
2. Your telephone number.
3. Clear and concise details of the fault.
4. The model number of your machine, the serial number (both found on the inside of the door) and the colour.
5. Enter the date here:

-
6. If you have taken out a Hotpoint Service Cover Plan.

Please make sure that you have all these details ready before making your call.

Retention of this Instruction Book

We suggest that you keep this book in a handy place for reference. It contains important details on the safe and proper use of your appliance.

If you sell, or pass on the appliance to someone else, or move house and leave it behind, make sure that this Book is also provided so that the new owner can become familiar with the appliance and safety warnings.

If the book is lost or damaged, a copy may be obtained by ringing your local spares centre (see back cover).

They will be able to tell you about the appliances, arrange to send a brochure, if you want one give you and indication of price and advice on local stockists.

**Thinking of
buying another
Hotpoint appliance?**



Hotpoint®

INFORMATION HOTLINE

For all you need to know about HOTPOINT

*Washing Machines, Dryers, Refrigeration, Dishwashers,
Dehumidifiers and Cooking appliances.*

BEFORE YOU BUY

RING 0541 50 60 70

Mon to Fri 8am to 8pm Sat & Sun 10am to 5pm



Hotpoint Service Cover

Satisfaction Guaranteed or Your Money Back

Hotpoint gives you a unique 'Satisfaction Guaranteed' promise - valid for ninety days after you have purchased your Hotpoint product. If there is a technical problem with your Hotpoint appliance, just call Hotpoint Service (see back page). If necessary we will arrange for an engineer to call. If the technical problem is not resolved under this Guarantee, Hotpoint will replace your appliance or, if you prefer, give you your money back. Your statutory rights are not affected, and the Guarantee is additional and subject to the terms of Hotpoint's Five Year Parts Guarantee.

Hotpoint's Free Five Year Guarantee

From the moment your appliance is delivered, Hotpoint guarantees it for **FIVE YEARS**.

- In the Five Years all replacement parts are **FREE** provided that they are fitted by our own Service Engineer. During the first year our Engineers time and labour is also free.
- Our guarantee covers loss of food in our refrigeration and freezer products up to £250 during the first year, subject to verification by one of our engineers.
- After the first year we will charge for our Engineers time and labour. We do, however, operate a range of Service Plans (see opposite) which, for an annual payment enables you to cover any repair costs which may be necessary.
- All our service repairs are guaranteed for twelve months in respect of our labour and any parts fitted.
- The appliance must be used in the United Kingdom, and must not be tampered with or taken apart by anyone other than our own Service Engineers.
- You may, however, buy parts which can be safely fitted without specialist knowledge or equipment. The correct fitting of such parts, provided they are genuine Hotpoint spares, will not affect your Guarantee. Parts are available from our Hotpoint Spares Centres (see back page).
- Our Guarantee does not cover the cost of any repair, or loss of food in refrigeration products, due to power failure, accidents or misuse. Nor does it cover the cost of any visits to advise you on the use of the appliance. Please read thoroughly the instruction book supplied with this appliance.
- If at any time during the Guarantee period we are unable to repair your appliance, we will refund any repair costs paid to us in the previous twelve months. We will also offer you a new appliance at a reduced charge instead of a repair.
- Our Guarantee is in addition to and does not affect your legal rights.
- Should you need independent advice on your consumer rights, help is available from your Consumer Advice Centre, Law Centre, Trading Standards Department and Citizens Advice Bureau.
- All Hotpoint servicing is carried out by our own Service Organisation located throughout the United Kingdom and Eire. We will be happy to deal with any problems which you may have.

Hotpoint's Extended Warranties

Whether you have just one or a number of Hotpoint appliances in your kitchen, Hotpoint has a range of Service Plans to give you complete peace of mind. They enable you to extend your one year labour guarantee so that you can have repairs completed **FREE** during the membership period.

Service Cover

We offer a number of payment methods; cheque, credit card or you can spread the cost and pay by direct debit (full details can be obtained on Free phone 0800 716356). This covers you for all repairs during the period of cover, which can be from 1 to 4 years. Service Cover also includes loss of food, up to the value of £250, in refrigeration appliances. There is also an option of Service Cover with Maintenance at an additional cost. This includes an annual Electrical and Safety check and replacement of any parts as necessary.

Kitchen Cover

An annual payment covers you for all repairs for all your Hotpoint appliances which are less than ten years old. It also covers the cost of loss of food up to £250 in our refrigeration and freezer products. There is also the option of Kitchen Cover with Maintenance at an additional cost. Any additional Hotpoint appliances purchased after you have joined Hotpoint Kitchen Cover will automatically be included during the annual period of cover without further charge.

Appliance Registration

To ensure that you have the opportunity to benefit from any of the above Service Schemes and other offers you should complete and return immediately the Appliance Registration Form/Questionnaire supplied with this appliance. Full details and costs of our Service Schemes, together with an application form, will be sent to you at the end of the first year of the guarantee.

Annual Safety/Maintenance Checks

Hotpoint strongly recommends that all its appliances are regularly checked for electrical and mechanical safety, whether or not they are covered by a Service Plan. Worn door gaskets or hoses may cause a leak on an appliance, which could become dangerous if neglected.

Proof of Purchase

For future reference please attach your purchase receipt to this booklet and keep it in a safe place.

Spares and Accessories

Spares and accessories can be ordered from your local Hotpoint Spares Centre (see back page), using the order form enclosed.

NOTE: Our Engineer will use every effort to avoid damage to floor coverings and adjacent units when carrying out repairs/service work, but in locations where the Engineer advises you that it will be impossible to move appliances without risk of damage, he will only proceed with your approval that no liability is accepted.



Hotpoint Service and Spares

FOR SERVICE: If you have a problem with your appliance ring our Nationalcall Service.

0541 500 500

You will automatically be connected to your nearest Service Office.

- **364 days a year service call booking**
- **Same day/next day service**
- **Repairs fully guaranteed for twelve months**
- **Five year parts guarantee from purchase date**

FOR GENERAL ENQUIRIES: Each Service Office has a Help Desk to answer general or technical enquiries about your appliance. Simply ring the Nationalcall Number (above) and ask for the Help Desk.

FOR SPARES and ACCESSORIES: Contact your Spares Centre for prices and availability. Telephone numbers for spares enquiries, for the various regions, are listed below.

Service Offices are open between 8.00am and 8.00pm Monday to Friday, 8.00am and 6.00pm on Saturdays and between 10.00am and 4.00pm on Sundays.

Spares Centres are open between 8.00am and 5.00pm Monday to Friday, and between 8.00am and 12.30pm on Saturdays.

- Service Office and Spares Centre
- Service Office only

LONDON

- **HARROW:** Unit 10, Crystal Way, Harrow, Middlesex, HA1 2HP
Spares Enquiries Tel: (0181) 863 4113

MIDLANDS/NORTH WALES

- **ALDRIDGE:** Westgate, Aldridge, W Midlands, WS9 8UX
Spares Enquiries Tel: (01922) 743377
- **NOTTINGHAM:** Ashling Street, Nottingham, NG2 3JB
Spares Enquiries Tel: (0115) 986 0387

NORTH

- **WETHERBY:** Sandbeck Lane, L22 4TW
Spares Enquiries Tel: (01937) 581221
- **MANCHESTER:** 44/46 Station Road, Heaton Mersey, Stockport, SK4 3QT
Spares Enquiries Tel: (0161) 432 0255

SCOTLAND

- **GLASGOW:** West Lodge Road, Blythswood Estate, Renfrew, PA4 9EN
Spares Enquiries Tel: (0141) 886 5611

SOUTH

- **MAIDSTONE:** Larkfield Trading Estate, New Hythe Lane, Larkfield, ME20 6SW
Spares Enquiries Tel: (01622) 716631
- **SOUTHAMPTON:** Unit R, Sth Hampshire Ind Park, Salisbury Rd, Totton, SO40 3SA
Spares Enquiries Tel: (01703) 867933

SOUTH WALES/SOUTH WEST

- **BRIDGEND:** 18 Western Ave, Bridgend Ind. Estate, Bridgend CF31 3SL
Spares Enquiries Tel: (01656) 766111

EAST

- **PETERBOROUGH:** Celta Road, PE2 9JB.
- **CHELMSFORD:** Industrial Buildings, Beehive Lane, Chelmsford, CM2 9TE

Note: Neither of the above two Offices have Spares Centres. For spares enquiries please ring Central Spares Administration (01733) 556520 – Telephone sales only

IRELAND

- **NORTHERN:** 256 Ormeau Road, Belfast, BT7 2FZ
Tel: (01232) 647111
- **EIRE:** 49 Airways Ind. Estate, Dublin 17
For Service Tel: 01 842 6088
For Spares Tel: 01 842 6836

AGENTS

CHANNEL ISLANDS - Service provided by Agents.

Normal Guarantees apply and certain Extended Warranty Schemes are available.

- JERSEY:** Reg Mauger Services Ltd
19 Don Street, St. Helier
Tel: (01534) 21625
or
Quick Fix Services
L'esperez, Rue de la Croix
St Clements.
Tel: (01534) 854808

GUERNSEY & SARK:

- or
Colin Torode Ltd, Grande Rue,
St. Martins, Guernsey
Tel: (01481) 38422
Lakers Appliance Service Ltd
Barras Lane, Vale
Tel: (01481) 51610

ALDERNEY:

- D A Walters, 32 High Street
Tel: (01481) 822686

ISLE OF MAN - Service provided by Agents. Normal

Guarantees apply and certain Extended Warranty Schemes are available from

- Partingtons
64 Duke St, Douglas
Tel: (01624) 673233
or
B Pascoe, Tromode Works,
Cronkbourne Village, Douglas
Tel: (01624) 676066
or
Manx Electricity Authority
PO Box 177, Victoria Rd, Douglas
Tel: (01624) 625811

SHETLAND, ORKNEY & WESTERN ISLES - Service provided by Agents. Normal Guarantees apply, but

Service Schemes are NOT available.

- SHETLAND:** Robertson & Peterson
Fort Road, Lerwick
Tel: (01595) 692557
- ORKNEYS:** Refrigeration Sales & Service
Hatstone Ind. Estate, Kirkwall
Tel: (01856) 875457
- WESTERN ISLES:** N B McCleod
Church Street,
Stornoway, Isle of Lewis
Tel: (01851) 705555
- OTHER ISLANDS:** Local Hydro Electric Shops
**EXCEPT ARRAN,
BUTE & SKYE-** Which are covered by Hotpoint

In accordance with its policy of progressive product design, the Company reserves the right to alter specifications. Hotpoint Ltd, Peterborough, PE2 9JB